

- Acc. to DIN EN 50205, DIN EN 61810-1, DIN EN 60664-1
- With forcibly guided contacts
- Low rated power consumption
- High mechanical service life
- High switching reliability due to crown contacts with large relative movement
- Compact size
- Optionally wash proof

Applications

- To be used in circuits for safety applications
- Escalators and walkways
- Elevators for men and load
- Railway technology

Approvals and Marking



Technical Data

Relay type		OA 5611	OA 5612
1.0 Relay coil			
1.1 Nominal voltage	DC V	6, 12, 24, 48, 60, 110 (others on request)	
1.2 Nominal consumption	W	0.6	0.8 / 1.0 ³⁾
1.11 Voltage range	U _N	0.7 ... 1.4	
1.13 Holding power (at 0.5 x U _N)	W	0.15	0.20 / 0.24 ³⁾
2.0 Contacts			
2.1 Contact arrangement		2 NO / 2 NC 3 NO / 1 NC	2 NO / 4 NC 3 NO / 3 NC 4 NO / 2 NC 5 NO / 1 NC
2.2 Contact material		AgSnO ₂ + 0.2 μm Au; AgNi + 0.2 μm Au, AgNi + 5 μm Au	
2.3 Rated insulation voltage	AC V	250	
Switching voltage min./max	V	AC/DC 10 / DC 250, AC 400 (AC/DC 100 mV / 60 V) ¹⁾	
2.4 Limit. contin. current I _b max.	A	3 e.g. 5 x 8 (see operating voltage limit curve)	
Switching current min./max	A	> 10 mA ⁴⁾ / 8 (1 mA / 0.3 A) ¹⁾	
2.5 Switching power min./max.	VA	3 / 2000 (1 mVA / 7 VA) ¹⁾	
Switching power min./max	W	0.1 ⁴⁾ / 200 (1 mW / 7 W) ¹⁾ (see limit curve for arc-free operation)	
2.6 Switching capacity			
to IEC/EN 60947-5-1 AC 15 ⁵⁾	AC V/A	NO: 250 / 2	NC: 250 / 1
to IEC/EN 60947-5-1 AC 15 ⁶⁾	AC V/A	NO: 250 / 3	NC: 250 / 2
to IEC/EN 60947-5-1 DC 13 ⁵⁾	DC V/A	NO: 24 / 1	NC: 24 / 1
at 0.1 Hz DC 13 ⁵⁾	DC V/A	NO: 24 / 4	NC: 24 / 4
to UL 508		B300	
2.7 Electrical life		at 1 s ON, 1 s OFF (see contacts service life)	
at AC 230 V, 5 A, cosφ = 1	switching cycles	> 3 x 10 ⁵ AgSnO ₂	> 2 x 10 ⁵ AgNi 10
at AC 230 V, 8 A, cosφ = 1	switching cycles	> 1.5 x 10 ⁵ AgSnO ₂	> 10 ⁵ AgNi 10
2.8 Switching frequency max.	switching cycles / s	10	
2.9 Response time / Release time	ms	typically 20 / typically 6	
2.10 Contact force	cN	≥ 10	
2.14 Contact gap	mm	> 1 (normal operation) / > 0.5 ²⁾ (under fault)	
3.0 Other			
3.1 Mechanical life	switching cycles	≥ 50 x 10 ⁶	
3.2 Temperature range	°C	- 40 ... + 85	- 40 ... + 85
3.3 Degree of protection		Solder line proof RT II as option wash proof RT III	
3.5 Vibration resistance		10 ... 200 Hz; 0.35 mm amplitude; 3 g max. IEC/EN 60068-2-6	
3.6 Climate resistance		Humid heat IEC/EN 60068-2-30	
3.7 Short circuit strength 1 kA / AC 250 V	AgSnO ₂	NO: 10 A gL / NC: 10 A gL EN 60947-5-1	
	AgNi	NO: 10 A gL / NC: 6 A gL EN 60947-5-1	

¹⁾ Values for AgNi 10-Contacts + 5 μm Au

³⁾ OA 5612.50 (2 NO / 4 NC)

⁵⁾ Values for AgNi-Contacts

²⁾ over entire service life, even when under fault and at 1.4 x U_N

⁴⁾ Typical values

⁶⁾ Values for AgSnO₂-Contacts

Technical Data

3.8	Insulation acc. to IEC 60664-1, EN 50178			
	Rated insulation voltage	AC V	250	
	pollution degree		3	
	Overvoltage category		III	
	Test voltage			
	Contact - Coil (1 min)	AC kV eff.	≥ 4	
	Contact - Contact (1min)	AC kV eff.	≥ 2.5	
	Open contact acc. to DIN EN 61810-1	AC kV eff.	1.5	
	Transient voltage			
	Contact - Coil (1,2 - 50 μs)	kV	≥ 6	
	Clearance and creepage distances			
	Contact - Coil	mm	≥ 8	
	Contact side-Contact side	mm	≥ 4.5	
	Contact - Contact	mm	≥ 4.5	
3.9	Weight	g	approx. 35	approx. 38
4.0 Packing				
4.1	on cardboard	piece	30	20
4.2	in case package	piece	150	100
5.0 Solder method				
5.1	Solder method /-temperature /-duration	°C / s	Wafer soldering / 260 / 5	

Design versions

U _N (DC V)	Voltage range (DC V)	OA 5611			OA 5612					
		R _{Coil} Ω ± 10%	.48	.52	R _{Coil} Ω ± 10%	.18	.54	.60	R _{Coil} Ω ± 10%	.50
			3NO, 1NC	2NO, 2NC		3NO, 3NC	4NO, 2NC	5NO, 1NC		2NO, 4NC
AgSnO-contacts + 0,2 μm Au										
6	4,2 ... 8,4	56	2491	2521	45	2401	2461	2571	36	2431
12	8,4 ... 16,8	240	2492	2522	180	2402	2462	2572	145	2432
24	16,8 ... 33,6	960	2493	2523	720	2403	2463	2573	600	2433
48	33,6 ... 67,2	3840	2494	2524	2880	2404	2464	2574	2300	2434
60	42,0 ... 84,0	6000	2495	2525	4500	2405	2465	2575	3600	2435
110	77,0 ... 154,0	20150	2496	2526	15125	2406	2466	2576	12100	2436
AgNi-contacts + 0,2 μm Au										
6	4,2 ... 8,4	56	2501	2531	45	2411	2471	2581	36	2441
12	8,4 ... 16,8	240	2502	2532	180	2412	2472	2582	145	2442
24	16,8 ... 33,6	960	2503	2533	720	2413	2473	2583	600	2443
48	33,6 ... 67,2	3840	2504	2534	2880	2414	2474	2584	2300	2444
60	42,0 ... 84,0	6000	2505	2535	4500	2415	2475	2585	3600	2445
110	77,0 ... 154,0	20150	2506	2536	15125	2416	2476	2586	12100	2446
AgNi-contacts + 5 μm Au										
6	4,2 ... 8,4	56	2511	2541	45	2421	2481	2591	36	2451
12	8,4 ... 16,8	240	2512	2542	180	2422	2482	2592	145	2452
24	16,8 ... 33,6	960	2513	2543	720	2423	2483	2593	600	2453
48	33,6 ... 67,2	3840	2514	2544	2880	2424	2484	2594	2300	2454
60	42,0 ... 84,0	6000	2515	2545	4500	2425	2485	2595	3600	2455
110	77,0 ... 154,0	20150	2516	2546	15125	2426	2486	2596	12100	2456

Ordering example

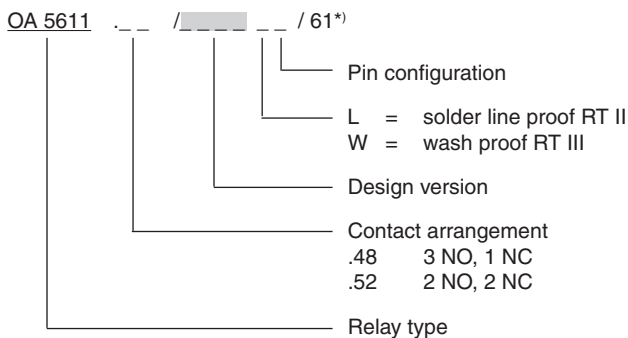

*) / 61 cURus approval

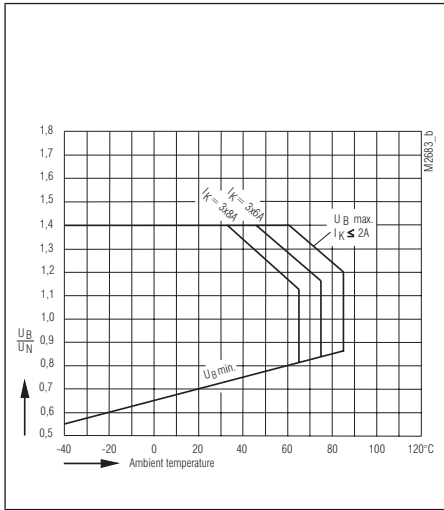

Operating voltage limit curve OA 5611

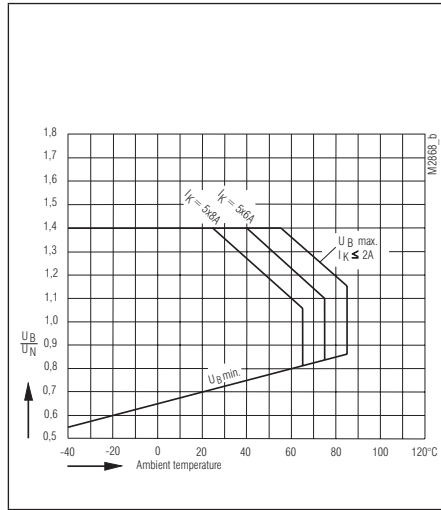

Operating voltage limit curve OA 5612

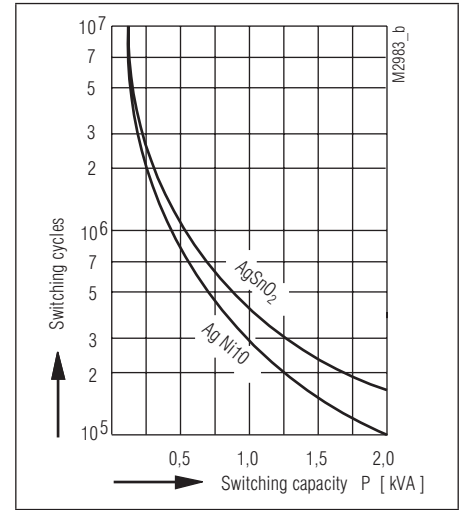

Contact service life

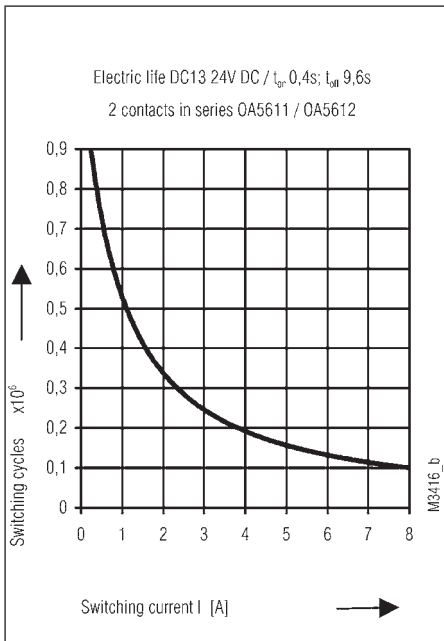

Contact service life

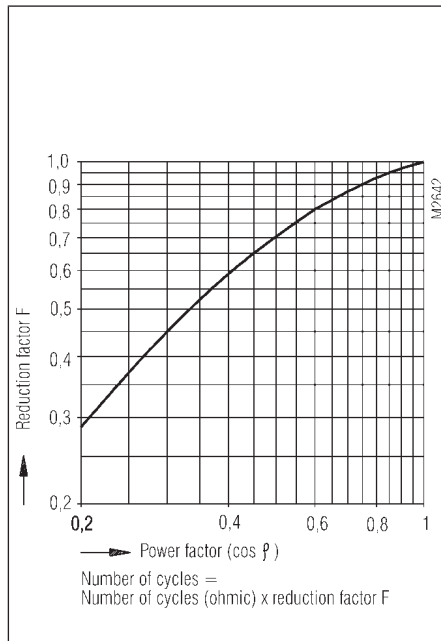

Reduction factor for inductive loads

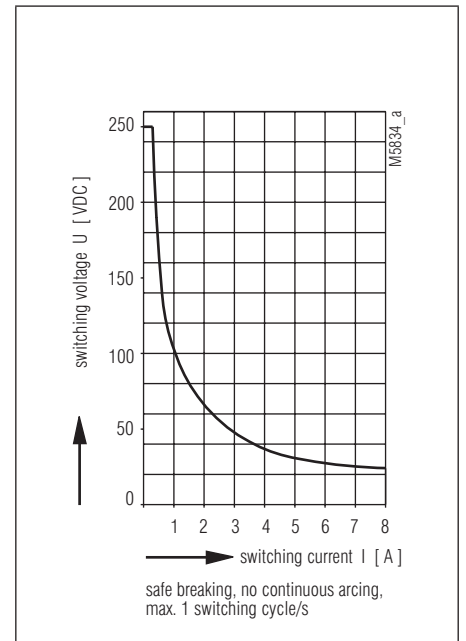

Limit curve for arc-free operation (load limit curve)

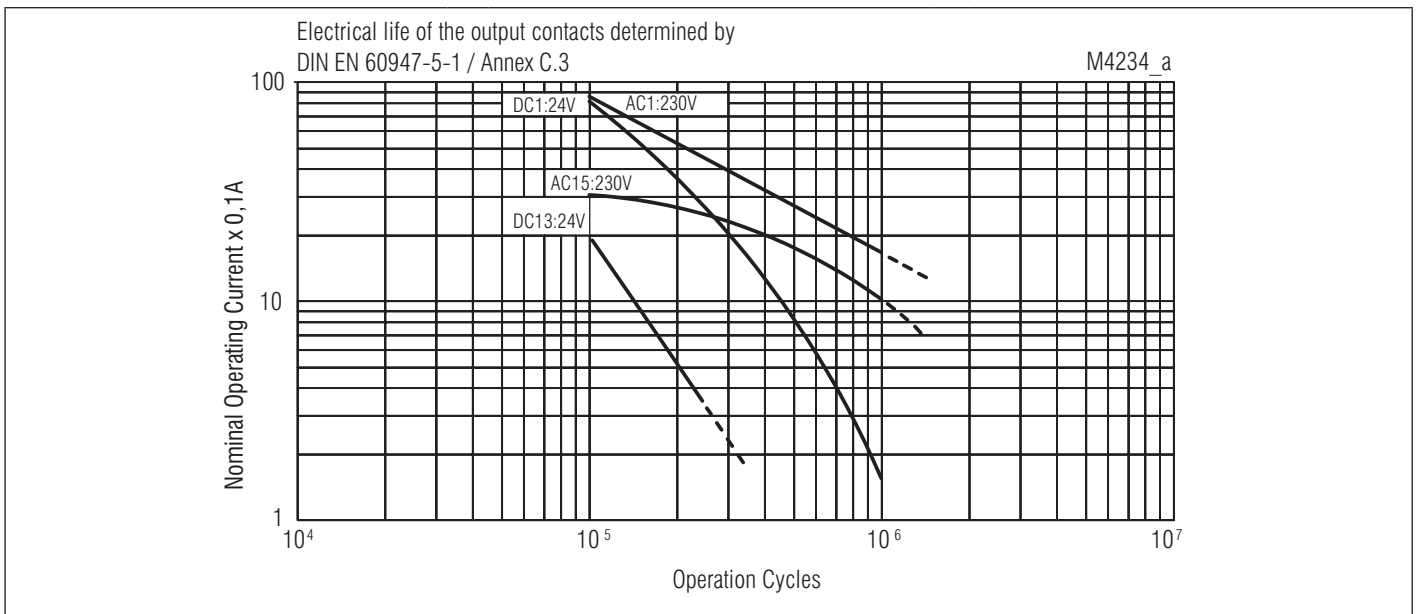

Electrical life

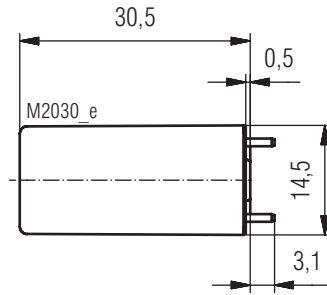
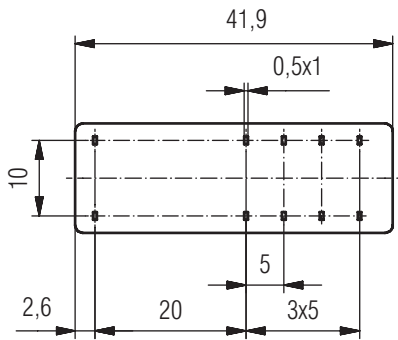

Drilling plan (solder side)

Pin arrangements OA 5611.52/...L1 2NO / 2NC

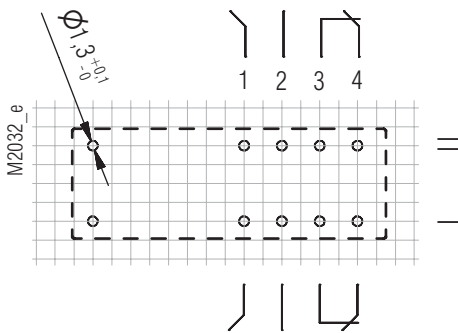

Pin arrangements OA 5611.52/...L4 2NO / 2NC

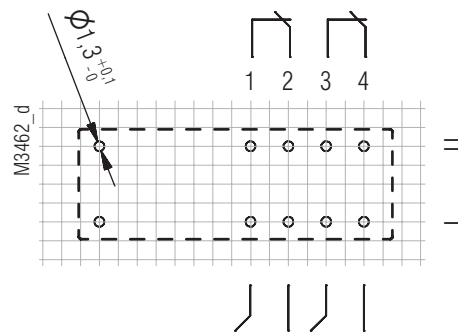

Pin arrangements OA 5611.52/...L5 2NO / 2NC

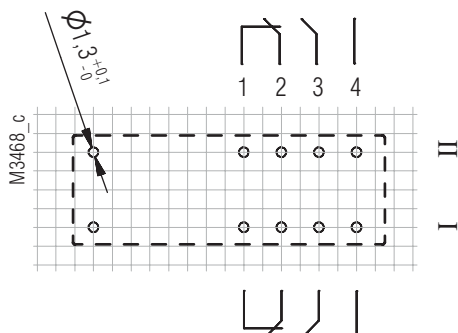

Pin arrangements OA 5611.48/...L1 3NO / 1NC

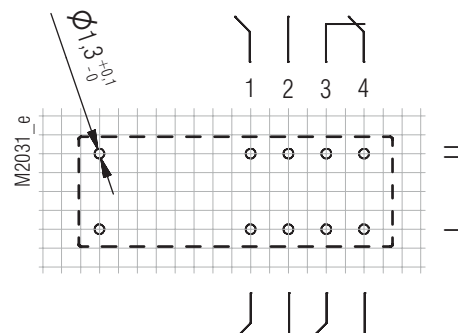

Pin arrangements OA 5611.48/...L4 3NO / 1NC

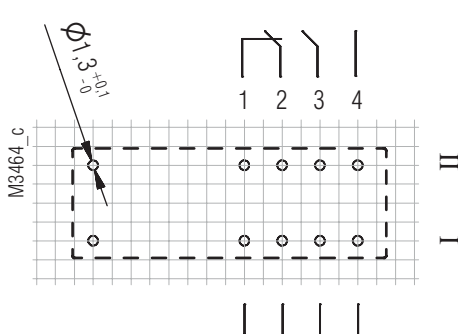

Pin arrangements OA 5611.28 1NO / 3NC

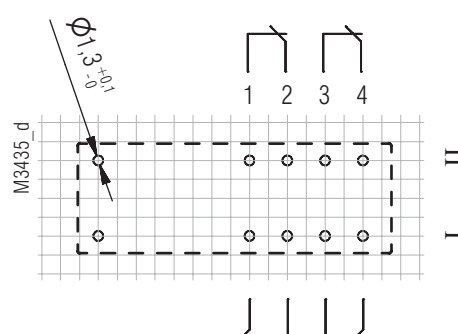

Connection for basic grid dimensions 2.5 mm as well as 2.54 mm according to IEC/EN 60097 and IEC 60326 average

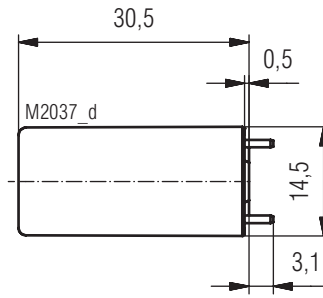
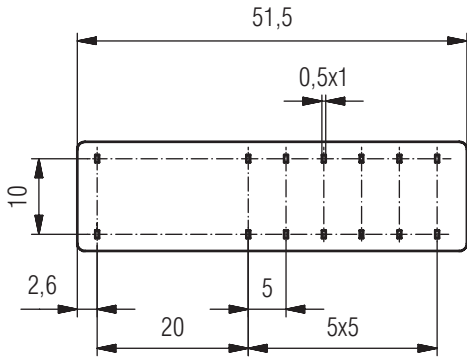

Drilling plan (solder side)

Pin arrangements OA 5612.60/...L4 5NO / 1NC

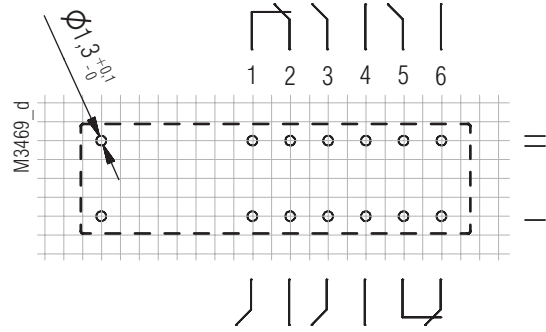

Drilling plan (solder side)

Pin arrangements OA 5612.60/...L1 5NO / 1NC

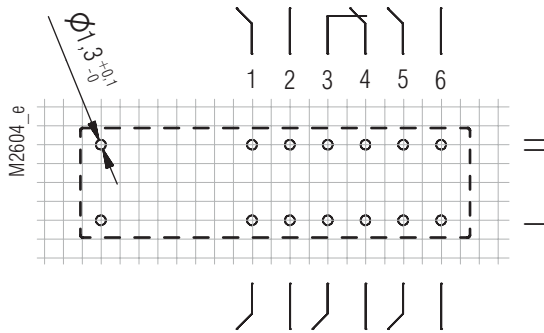

Pin arrangements OA 5612.54/...L4 4NO / 2NC

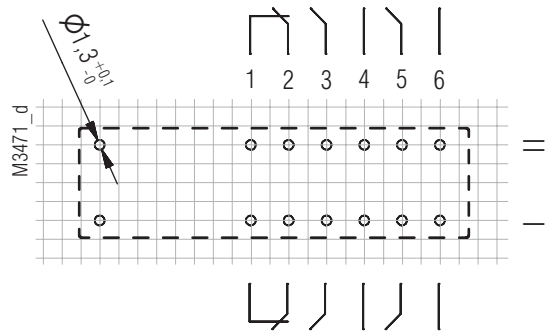

Pin arrangements OA 5612.54/...L1 4NO / 2NC

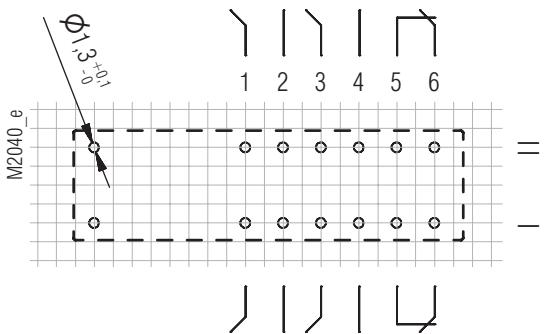

Pin arrangements OA 5612.50/...L4 2NO / 4NC

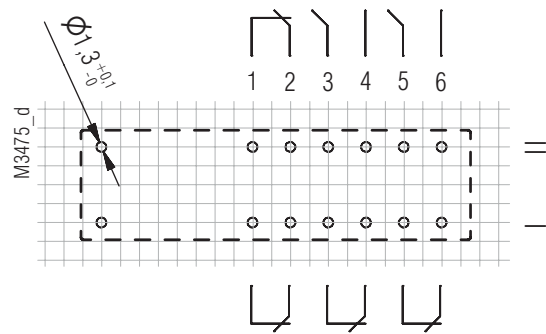

Pin arrangements OA 5612.50/...L1 2NO / 4NC

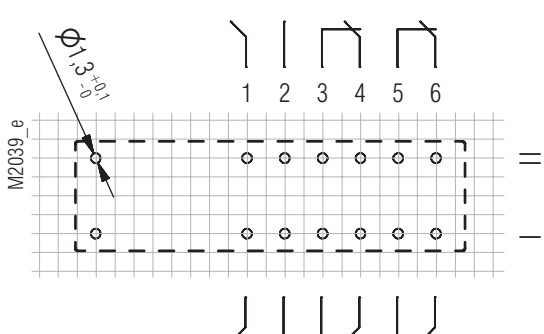

Pin arrangements OA 5612.18/...L1 3NO / 3NC

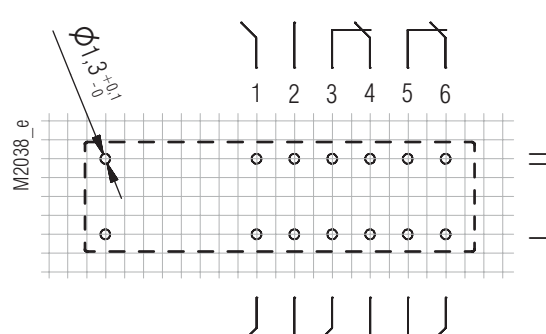

Connection for basic grid dimensions 2.5 mm as well as 2.54 mm according to IEC/EN 60097 and IEC 60326 average

Socket ET 1415.031

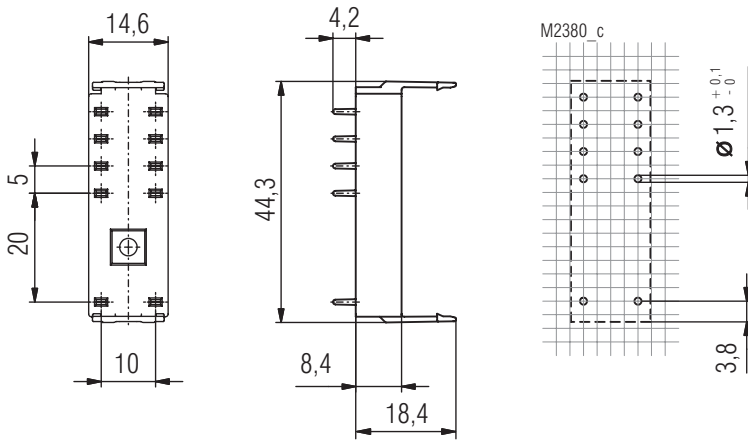

Article number: 0049512

Socket ET 1415.032

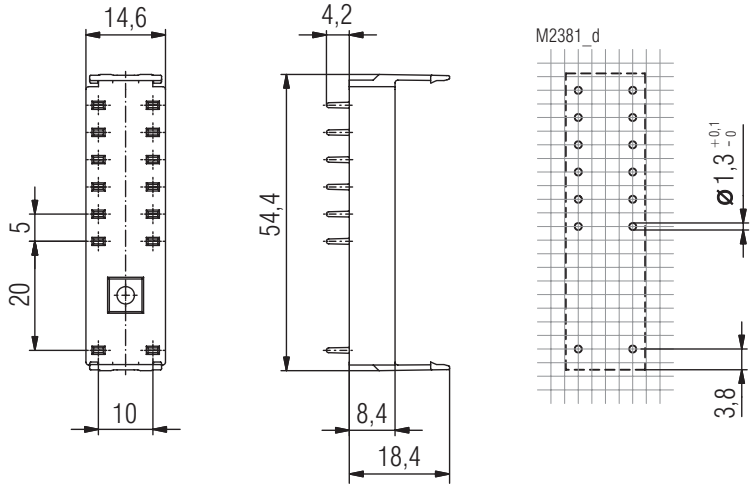

Article number: 0049513